

---

# Installation & Quick Start Guide

## Aqua 50 PC (Fedora 18)

---



NOTE: During power up, you will be asked to log in as User “Aqua” and the password is “aqua”

## 1. Introduction

Congratulations on the purchase of your Aqua 50 PC. It is recommended that your new computer is installed by a professional installer. **The Aqua 50 PC is 12v ONLY** and must not be connected directly to a 24v DC supply. Please consult your dealer or with Digital Yacht on suitable 24v to 12v DC-DC adaptors.

** Due to different battery banks, AC supplies, inverters, grounding, etc. on boats, always connect and disconnect devices and cables to the Aqua 50 PC with the PC and other devices turned off – particularly USB and Monitor cables.**

## 2. Before you start

You will need the following items and tools to complete the installation:

- A USB Keyboard and Mouse
- A suitable Monitor with VGA or HDMI input
- Access to 12V DC power supply where the unit is to be installed
- Crimps, terminal block or other connectors suitable for connecting DC/Signal wiring
- M3 or M4 screws or other fixings appropriate to the mounting location

The Aqua 50 PC has LINUX Fedora 18 pre-installed. A complete suite of software programs are also pre-installed but if you want to install additional LINUX software, then you will need to have an internet connection. This is probably best done in a home/office environment.

Other optional items you may wish to have with you during installation include;

- Suitable USB Memory stick for transferring software and data
- A powered USB hub if you intend to connect more than 4 USBs devices to the Aqua 50 PC

## 3. Installation

Before starting installation select a suitable location for the Aqua 50 PC. The unit is not water resistant and should be mounted in a dry location where it will not come in to contact with water or excessive moisture. When locating the unit you should consider:

- Routing of power, USB and NMEA cables to the unit
- Provision of sufficient space behind the unit for cable connections
- Getting access to the Aqua 50 PC for plugging in USB devices
- Maintaining the compass safe distance of 0.5m

### Installation Step 1

- Run a suitable 12v DC supply to the location where the Aqua 50 PC will be mounted.
- The Aqua 50 PC normally consumes around 1A at 12v but will consume more power if you are powering a 12v monitor or lots of USB devices from the Aqua PC.
- Ensure a suitable in-line fuse is fitted or circuit breaker (maximum 10A).
- Run any USB or NMEA interfacing cables to the location where the Aqua 50 PC will be mounted.
- Do not make any connections yet.

** The USB Interface Standard specifies that USB cables should be no longer than 5m without using a special powered USB extender cable – ensure that the total USB cable length from the Aqua 50 PC to any USB device is < 5m.**

## Installation Step 2

- The Aqua 50 PC is supplied with four mounting brackets which are screwed (wrong way round) to the base of the Aqua 50 PC for transit. Unscrew the brackets, reverse them and screw them back in place. Use suitable fixings (not supplied) to fix the Aqua 50 PC to a flat surface – using the dimensions and details shown in the drawing below. Note that the unit may be installed in any orientation.

### Fixing location drawing

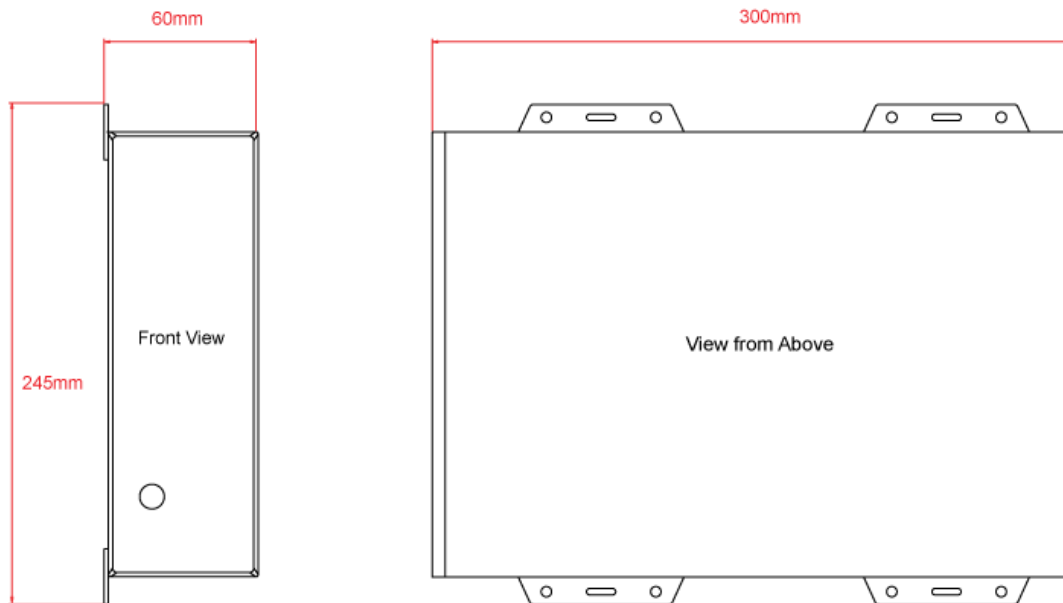

### Photo of Aqua 50 PC Rear Panel



### Installation Step 3

- On the rear of the Aqua 50 PC is a single black cable that has eight wires. This is the Power/IO cable. Connect the Red (+) and Black (-) wires in the Power/IO cable to the ship's 12v DC supply.
- **Ensure that the supply is connected via a suitable fuse or suitable circuit breaker (in the positive power connection).** A 5A fuse/circuit breaker is recommended for most installations and 10A is the maximum value that should be used.
- Do not try to turn on the Aqua 50 PC yet.

### Installation Step 4

- The connections on the rear of the Aqua 50 PC are as follows;

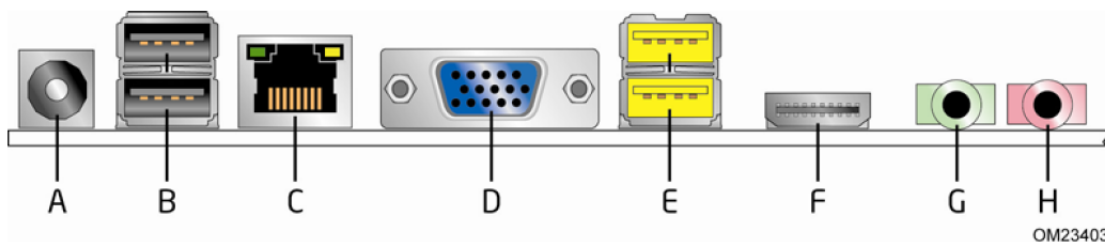

Item	Description
A	DC input jack
B	USB ports
C	LAN connector
D	VGA connector
E	High-current/fast charging USB ports
F	HDMI connector
G	Analog line out
H	Microphone in

- The wires in the eight core Power/IO are as follows;
  - RED - Power + (12v or 24v)
  - BLACK - Power - (0v)
  - ORANGE - COM 1 TX+
  - YELLOW - COM 1 RX +
  - GREEN - COM 1 Ground (-)
  - BROWN - COM 2 TX+
  - BLUE - COM 2 RX+
  - GREY - COM 2 Ground (-)
- Connect a USB mouse and keyboard to the any of the four USB ports on the Aqua 50 PC
- Connect a suitable monitor or monitors to the VGA and/or HDMI connectors on the Aqua 50 PC
- If you wish to connect any USB devices that have rechargeable batteries i.e. iPhone or need extra current i.e. external hard drive or DVD player, connect them to the Yellow "High Power" USB sockets.

** The DC Input Jack connector should not be used. Please ensure that the supplied protective cap is always fitted and do not attempt to connect any devices or external power supplies to this connector.**

- To connect NMEA devices to the Aqua 50 PC you can connect them directly to the two COM port wires in the Power/IO cable. A couple of typical examples are shown below;

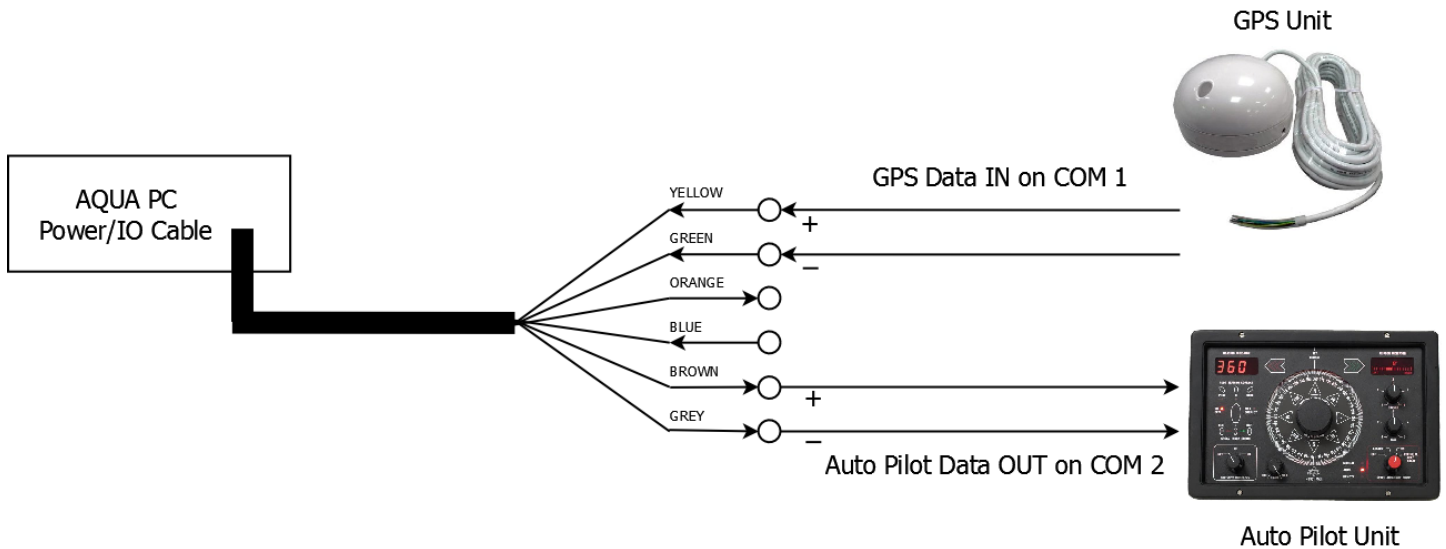

- Once all devices are correctly connected to the Aqua 50 PC ensure the 12v DC power is connected i.e. the circuit breaker is ON (if fitted). Press the Power switch on the front of the Aqua 50 PC and the Power and Hard Disk LEDs should come on as the PC starts its power up sequence.
- Installation is now complete.

## Operation

The Aqua 50 PC is pre-installed with LINUX Fedora 18. During the power up sequence, you will be asked to login as User "Aqua" and the password for this is "aqua" (case sensitive). When using LINUX, it is sometimes necessary to log in as the "Root" administrator user and the password for this is "Fedora18" (case sensitive).

Once the Aqua 50 PC has finished booting, you will see the "very clean" Fedora Desktop as shown below;

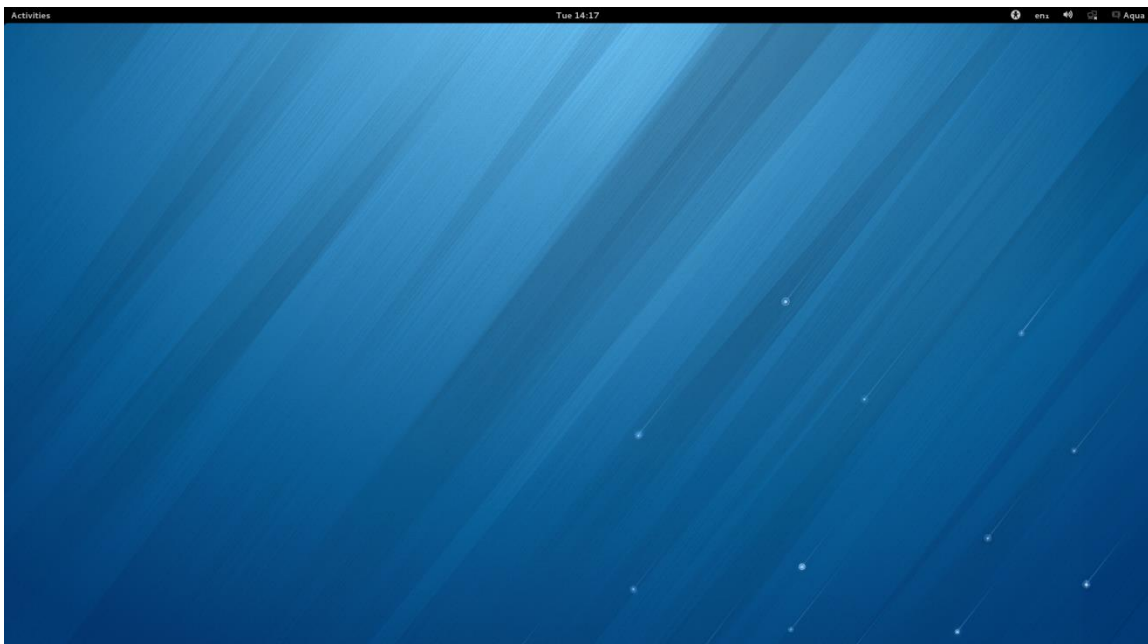

To display the Application Launcher Bar, move the cursor to the top left hand corner and you will see the bar appear down the left hand side of the screen, as shown below;

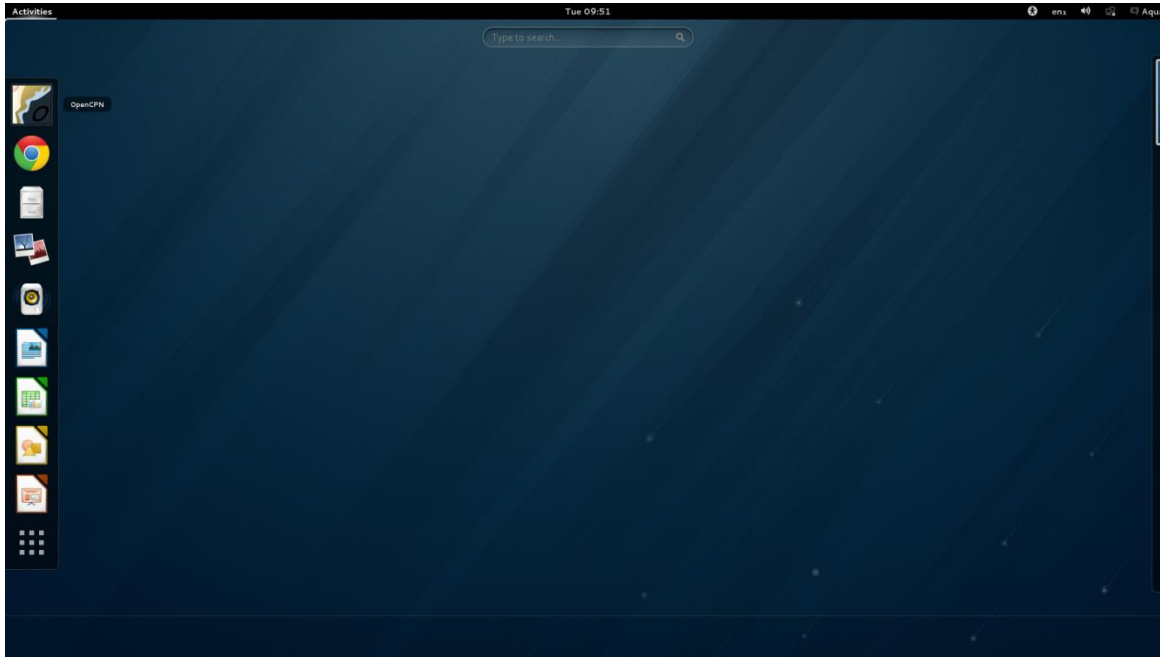

We have set this up with the most common apps but you can easily remove and add items to this bar. The top icon is OpenCPN which has been pre-installed and includes the more detailed world map, but no other charts. For more information on OpenCPN and the charts that it supports, visit <http://opencpn.org/ocpn/>

We have installed Google Chrome (Firefox is also pre-installed) and Fedora 18 comes with a file manager, photo editing, Music Player and Libre Office that includes a word processor, spreadsheet, presentation and drawing package. All of these apps have been setup on the Launcher bar for you.

The bottom icon opens the Applications screen where you can easily access the other applications that are included with Fedora 18 – see image below;

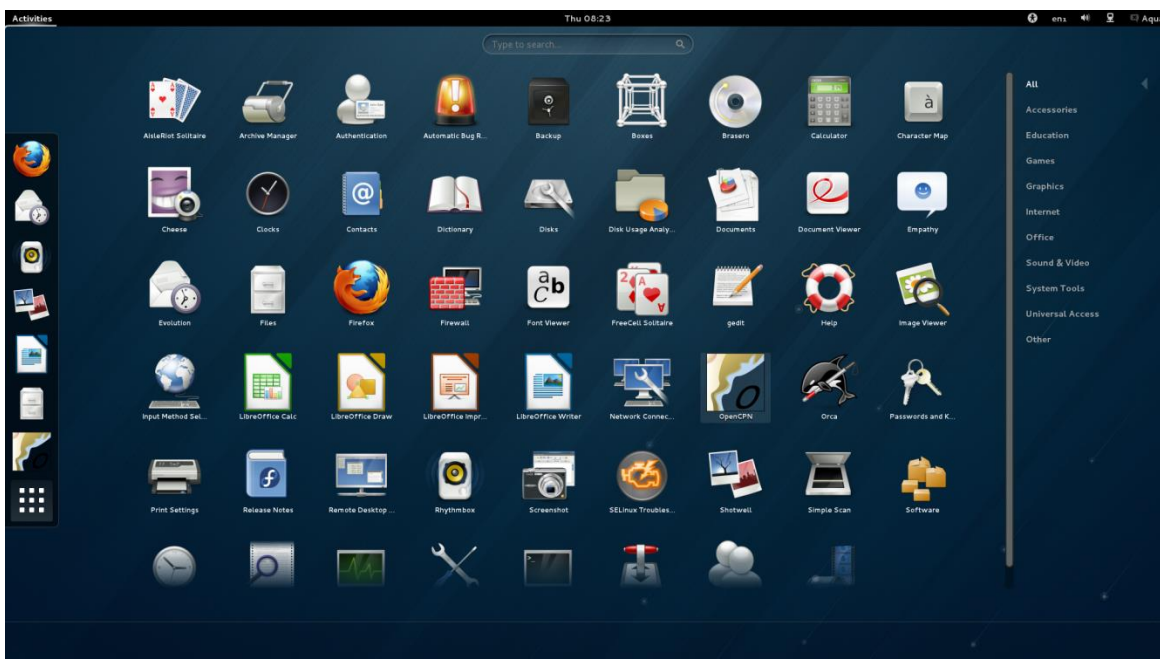

More applications are available for download, by clicking on the "Software" icon shown in the bottom right hand corner of the image above. For more information on Fedora 18 please visit <http://fedoraproject.org/en/>