

# iKConnect Wireless Router

Installation and instruction Manual



## 1. Introduction

Congratulations on the purchase of your iKConnect Wireless Router. It is recommended that your router is installed by a professional installer. If the iKConnect is to be connected to the internet via a Digital Yacht WL70 long range Wi-Fi Adaptor or to an iKommunicate gateway, it is recommended that this installation/configuration is carried out by someone with suitable IT experience and knowledge of Ethernet networks.

The iKConnect can be used in the following configurations;

- 1) As a simple Wireless Access Point or Wireless Router for setting up a wireless network on-board a boat
- 2) In conjunction with a Digital Yacht WL70 to share the long range internet connection with everyone on-board
- 3) With an iKommunicate NMEA to Signal K gateway to provide wireless navigation data.
- 4) A combination of the above configurations

 **Before operating the unit you should familiarise yourself with this Quick Start manual and any manuals for the equipment you intend to interface with iKConnect.**

## 2. Before you start

You will need the following items and tools to complete the installation:

- The iKConnect Router
- RJ45 Cat 5 cable to connect between the iKConnect and your Ethernet network
- A connection to the boat's 12v DC supply where the unit is to be installed.
- Two suitable pan head screws for fixing the iKConnect in a suitable mounting location.

To test and configure the iKConnect you will need:

- A PC, Mac, iPhone/iPad or other wireless device that has a web browser such as IE, Chrome, Firefox, etc.

To connect the iKConnect to an iKommunicate, you will need a:

- An iKommunicate Gateway
- A standard RJ45 Network cable

To use the iKConnect to share a long range Wi-Fi internet connection on board the boat, then you will need a;

- Digital Yacht WL70 Long Range Wi-Fi Adaptor

## 3. Installation

Before starting installation select a suitable location for the iKConnect Router. The unit is designed for below deck mounting on board a boat and is not water resistant. It should be installed in a cool, dry location and can be mounted on a vertical or horizontal surface. When locating the unit you should consider:

- Routing of power and network cables to the unit.
- Provision of sufficient space around the unit for cable connections.
- Routing of optional network connections to a WL70 Long Range Wi-Fi Adaptor (if necessary).
- Maintaining the compass safe distance of 0.5m.
- Best location for Wi-Fi reception i.e. center of the boat and not inside a metal enclosure



## Installation Step 1

- Siting of the iKConnect is critical for Wi-Fi reception. The unit features a 3dB antenna which should give up to 30m range but it is important that the unit is sited in a central location within the boat to try and ensure that Wi-Fi reception is good in all areas of the boat.
- If the unit is to be hidden away behind a bulkhead, Wi-Fi reception maybe reduced. In this situation, it is advisable to fit SMA extension cables, which are available from many suppliers. The Extension cable length should be kept to a minimum, between 1m and 3m would be recommended.
- To fit the SMA Extension cables, unscrew the 3dB antenna from the iKConnect and screw the extension cable between the iKConnect and the antenna. Now you will be able to hide the iKConnect unit behind a bulkhead and just mount the antenna in the cabin for maximum Wi-Fi range.
- Provide power connections to the unit from the boat's supply. Power is connected to the iKConnect via the supplied; 2.1mm DC Jack Plug cable assembly. The cable has two wires; the Red wire is the positive (+) connection and the Black wire is the negative (-) connection. Connect the wires to the nearest source of primary 12V DC power. **Ensure that the supply is connected via a suitable 1A fuse or circuit breaker.** Add the fuse in the positive power connection to the unit if necessary.
- **IMPORTANT** – if connecting the iKConnect to a Digital Yacht WL70 Long Range Wi-Fi Adaptor, remember that the WL70 only has a 5m USB cable, which should not be extended, so make sure that the iKConnect is sited within 5m of where the WL70 is mounted.

## Installation Step 2

- Use suitable fixings (not supplied) to fix the iKConnect to a flat surface – using the dimensions and details shown in the drawing below. Note that the unit may be installed in any orientation.

### Dimension drawing

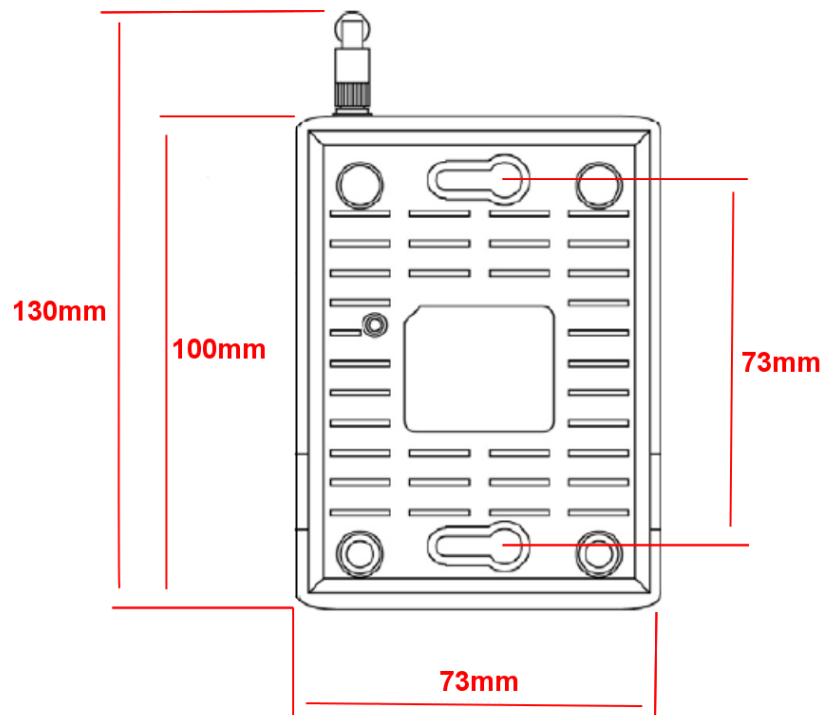

- Once the unit is secured in place, position the antenna so that it is pointing vertically upwards or if connected via an extension lead, mount and secure the antenna within the cabin area.



### Installation Step 3

- The following steps only need to be followed if you are connecting the iKConnect to a Digital Yacht WL70 long range Wi-Fi Adaptor.
- Using its integrated USB cable, plug the WL70 in to the USB socket on the front of the iKConnect.
- The WL70 is only detected during power up and we do not currently support “hot plugging” of the WL70 whilst the iKConnect is powered up. Therefore always plug and unplug the WL70 whilst the iKConnect is powered off.

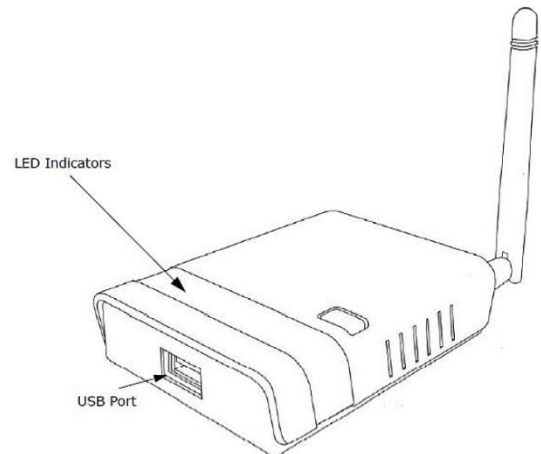

### Installation Step 4

- The following steps only need to be followed if you are connecting the iKConnect to another wired network device, like the Digital Yacht iKommunicate gateway.
- Connect the supplied RJ45 network cable between the network device's Ethernet socket and the iKConnect's “RJ-45 LAN Port” socket.

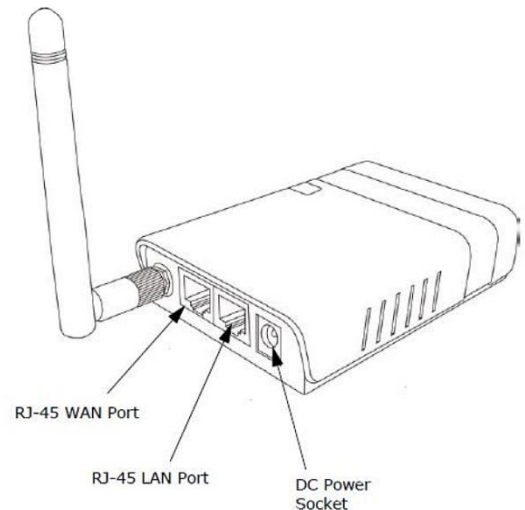

### Installation Step 5

- Now that we have all of the connections made, we can apply power to the iKConnect
- As the iKConnect powers up the LEDs on the top side of the unit will briefly illuminate and then only the Power LED will stay illuminated.
- As the iKConnect initialises and configures itself, the WPS button will flash for about 15 seconds and after that stops the iKConnect should be fully powered up and ready to be used.
- During normal operation, the Power and WPS LEDs will be illuminated and also the LAN, USB, WAN and WLAN LEDs if you have devices connected to these ports.
- As network traffic is transmitted/received on any of the network ports, the relevant LED will flash.
- On the following page, is a typical network diagram showing how the iKConnect can be used as the wireless router on the boat.

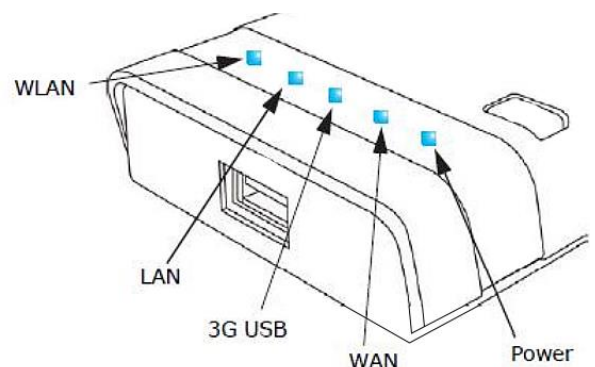

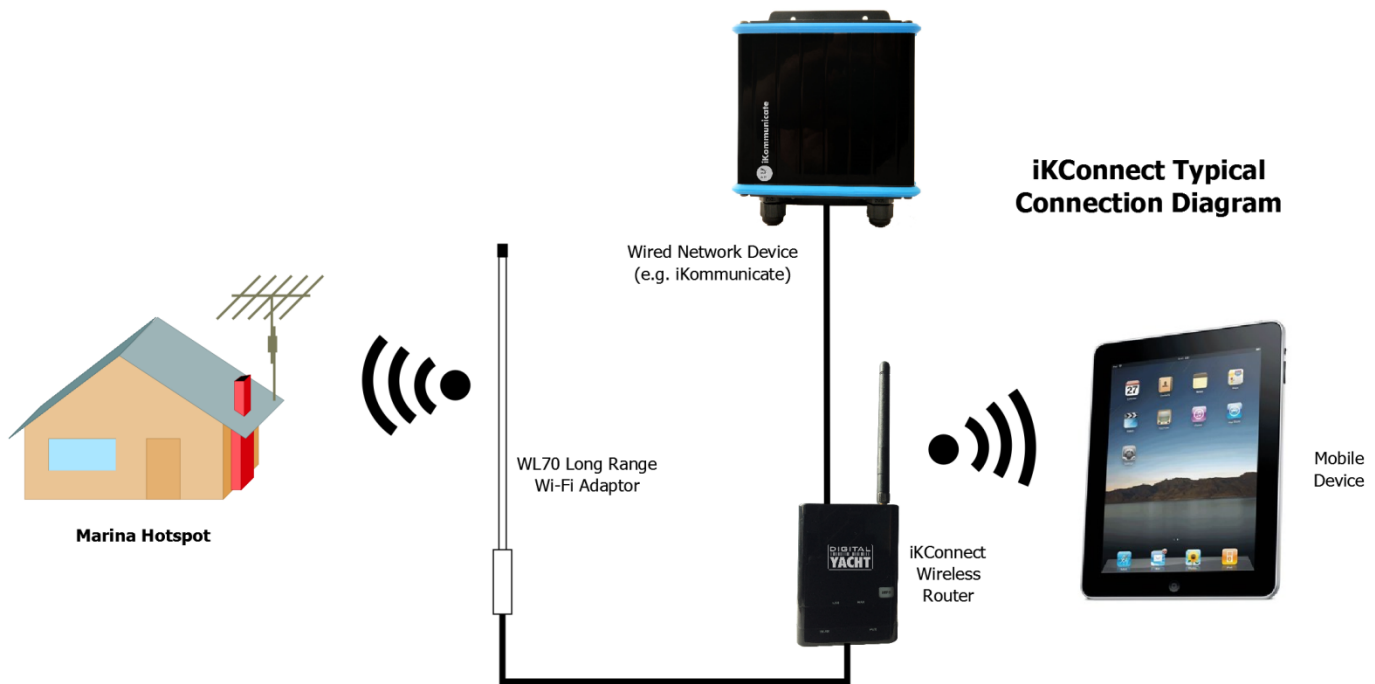

## 4. Network Configuration

Digital Yacht have pre-configured the iKConnect so that in most situations it will work straight out of the box with no additional configuration required. The iKConnect default settings are as follows;

IP Address	-	192.168.1.1
Subnet Mask	-	255.255.255.0
DHCP Range	-	192.168.1.100 to 192.168.1.250
SSID	-	iKConnect
Password	-	ikconnect

The iKConnect network settings have been chosen for maximum compatibility with marine equipment and marina hotspots and we do not recommend changing them unless you are experienced with configuring PC networks and wireless routers.

We do however, recommend that you change the default wireless Password and SSID, as it would be very easy for someone to read this manual online, discover the default settings and then connect to your wireless network. All changes can be easily made via the Router's web interface using a browser on any device connected to the iKConnect network.

Bring up the iKConnect web interface by typing 192.168.1.1 in to the address bar of your device's browser and you should see the iKConnect login screen as shown in Fig 1.

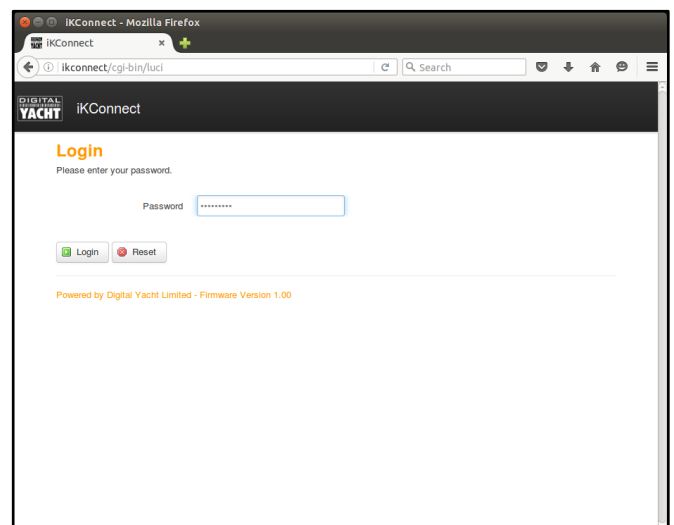

Figure 1



The password to login is “ikconnect” and we **recommend that you do not change this** in the Administration page. Once logged in you should see the Status page as shown in Fig 2. To change the SSID and wireless Password of the iKConnect wireless network, go to the “WiFi” page shown in Fig 3, by selecting the **“Network>WiFi”** menu option.

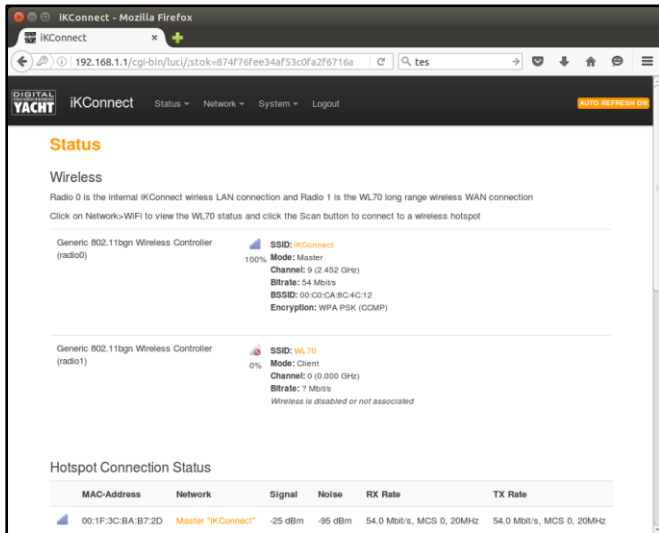

Figure 2

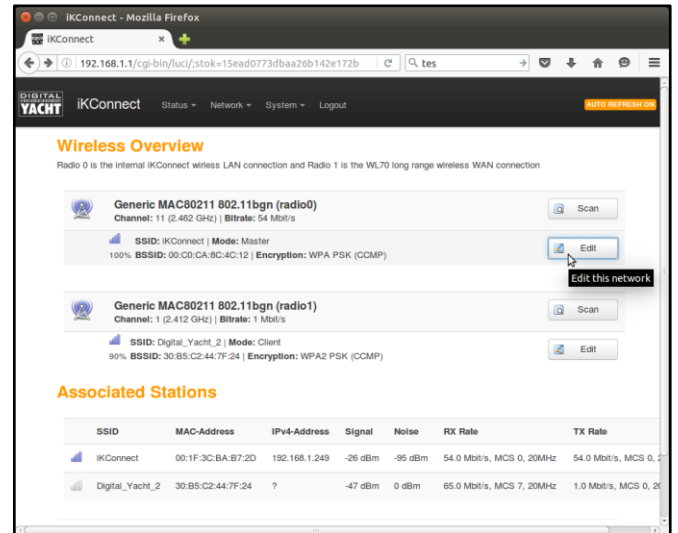

Figure 3

In the Wireless Overview screen you will either see just a single wireless network (Radio 0) or two wireless networks if you have a WL70 plugged in to the iKConnect USB port. The internal iKConnect wireless network is always listed first and this is the one that you want to change, so click the “Edit” button for the iKConnect network. You should now be taken to the iKConnect network setting page shown in Fig 4.

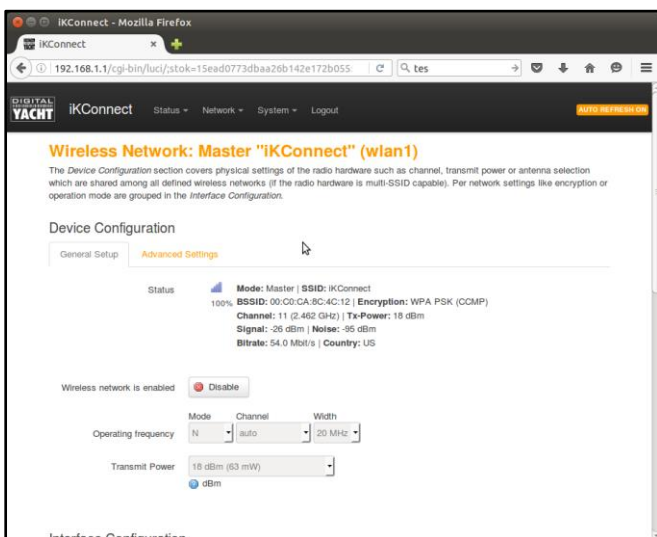

Figure 4

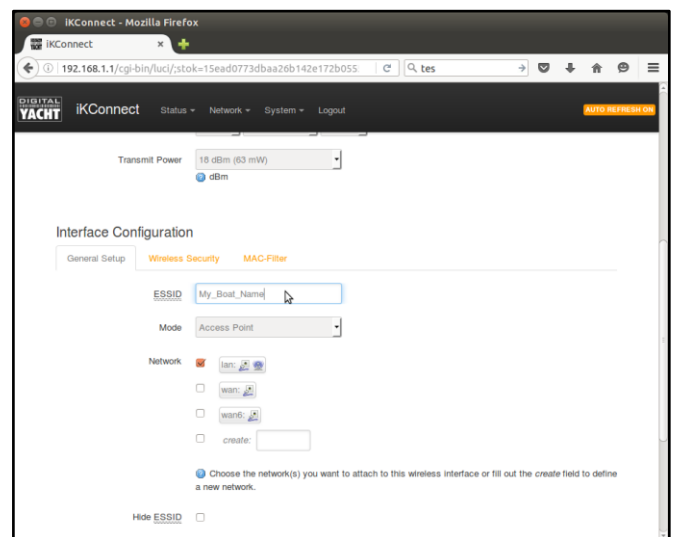

Figure 5

Scroll down the page to the Interface Configuration section and change the SSID from “iKConnect” to the name of your boat or some other suitable wireless network name. Please avoid the use of spaces (use \_ symbol) and any other special characters that might cause problems with some operating systems. For more information on SSID selection, please read an [article about SSIDs on our blog](#).

Once you have changed the SSID, click on the “Wireless Security” tab in the Interface Configuration section and change the password. You can click on the two green arrow icon to the right of the password box, to display the actual characters rather than the hidden asterisks.

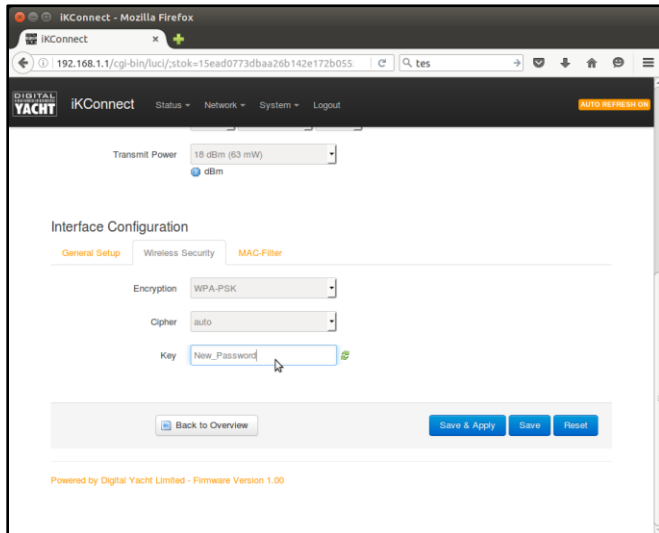

Figure 6

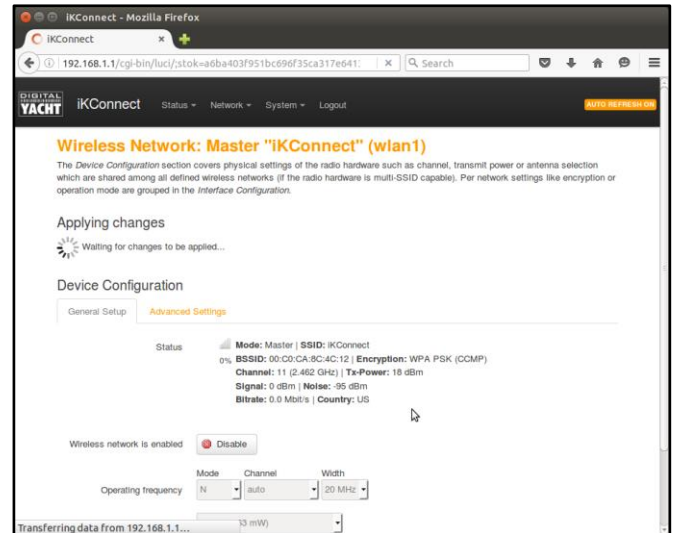

Figure 7

Once the password is changed, click on the “Save+Apply” button and the screen in Fig 7 will be displayed as the changes are applied. Once complete you will go back to the Wireless Overview screen in Fig 3 but with the new SSID shown.

## 5. Using iKConnect with WL70

If you are using the iKConnect with the Digital Yacht WL70 long range Wi-Fi adaptor, then whenever you arrive at a new marina, you will need to login to the iKConnect to make the WL70 connect to the marina hotspot. This can be done from any Smart Phone, Tablet or Computer that is connected to the iKConnect, by opening the browser on the device and typing the iKConnect IP address (192.168.1.1) in to the browser’s address bar. You will then see the iKConnect login page shown previously in Fig 1.

Enter “ikconnect” as the password and then from the “Status Overview” page (Fig 2) select the “Network>WiFi” menu option to take you to the Wireless Overview screen (Fig 8 below), where the WL70 should be shown as the second wireless network in the list (radio1). Click on the WL70 networks “Scan” button and after a couple of seconds, a new Wireless Scan page will be shown that lists all of the wireless hotspots the WL70 detected, as shown in Fig 9.

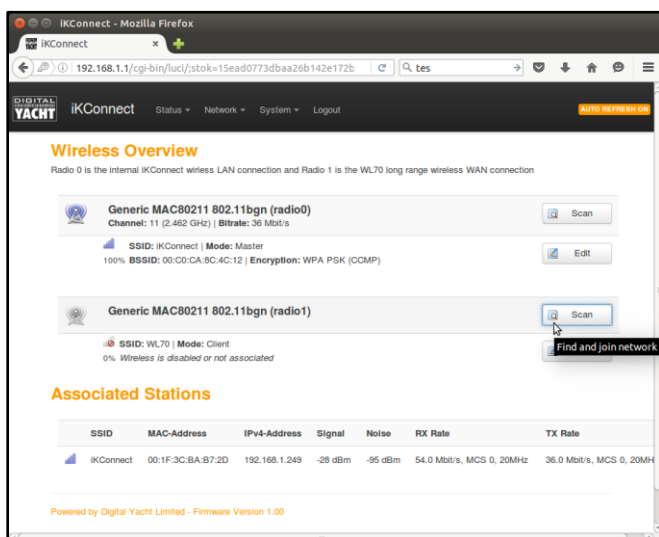

Figure 8

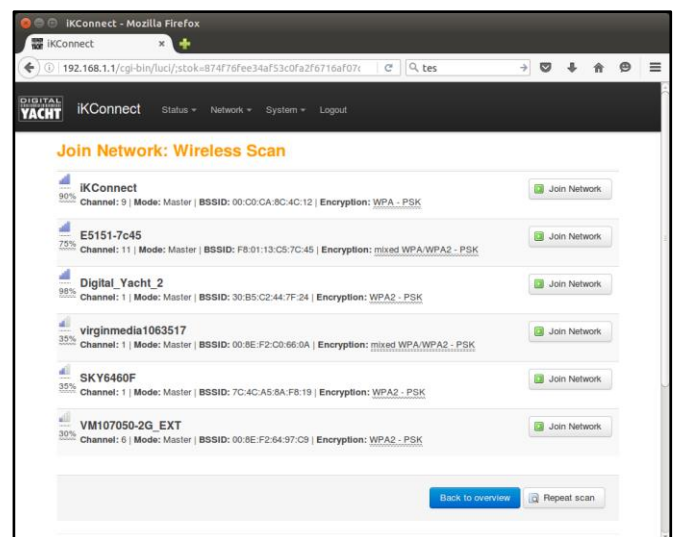

Figure 9



Choose the wireless hotspot that you want to connect to and click the relevant “Join Network” button. Now you will need to enter a password if the hotspot is WEP, WPA or WPA2 encrypted or if the network has no protection, just click on the “Submit” button. You will now go to a screen that lists the settings of the new wireless connection you are about to create (see the blue “UnSaved Changes” box) and you need to scroll down to the bottom of the screen and click the “Save and Apply” button to make the changes and connect the WL70 to the wireless hotspot.

NOTE – normally the password is hidden with asterisks, but if you click on the two green arrows icon, the password that you are typing can be seen to be sure you are typing it correctly.

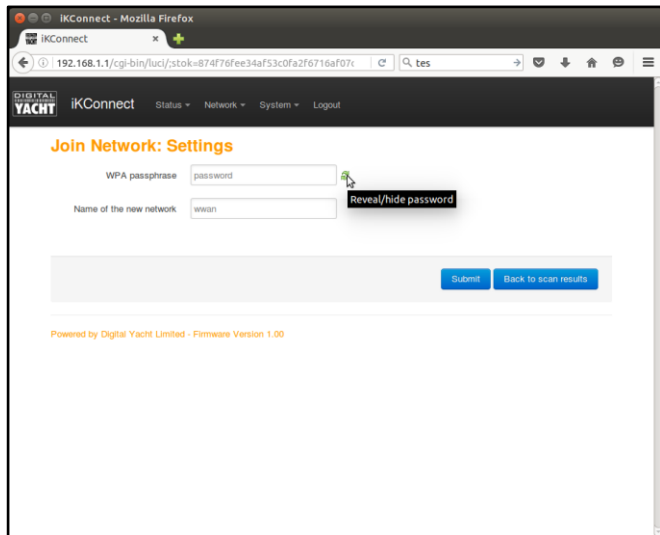

Figure 10

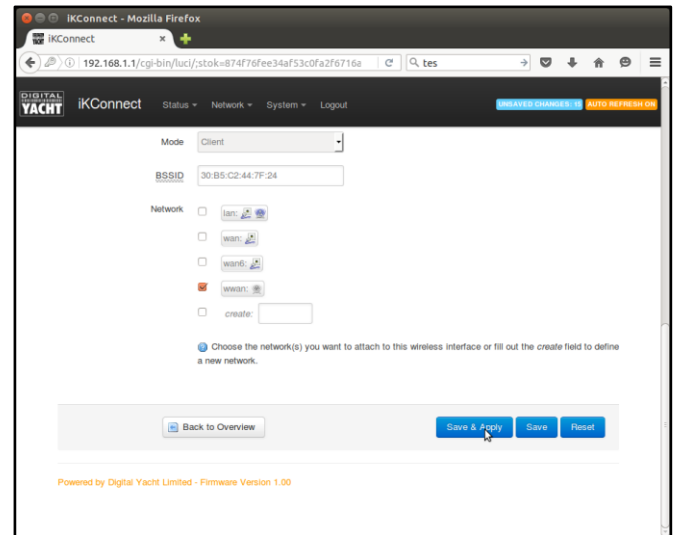

Figure 11

After a few seconds the WL70 will be connected to the hotspot and it should be possible to browse the internet by typing in a website address (URL) in to your browser’s address bar. You may find that you are redirected to the “Welcome/Register/Login” type page of the marina hotspot where you will need to follow the instructions, register, type in a voucher code, etc. before you can access the internet.

## 6. Using iKConnect with other Network Devices

iKConnect has two network connectors for connecting it to other wired network devices as shown in Fig 12. By default the left hand connector is setup to be a WAN connection for connecting to the Internet via a long range Wi-Fi adaptor like Digital Yacht’s WL510 or a 3<sup>rd</sup> Party 3G/4G device.

The right hand network connector is a LAN connector for connection to other network devices such as Digital Yacht’s iKommunicate Signal K Gateway or 3<sup>rd</sup> Party devices like a Fusion Entertainment system.

The right hand LAN connector can also be used to provide power to iKConnect via Power over Ethernet (PoE).

### IMPORTANT NOTE

Only a passive 12v DC PoE injector should be used and iKConnect will be damaged if connected to an active 24v or 48v PoE system.



Figure 12





## 7. Resetting iKConnect

iKConnect has many settings and functions which have been optimised for best performance and in most cases should not need to be adjusted. However, it is not uncommon for users to make changes and adjustments, either intentionally or by accident that result in iKConnect not working correctly. Should this happen, it is an easy process to reset iKConnect to its factory defaults.

Apply power to iKConnect and allow 30 seconds for it to fully boot up. Now turn the unit over and locate the Reset switch (see Fig 13). With the end of a pencil, ball point pen or other similar object gently press in the Reset switch and hold it for 10 seconds. When you release the switch you should see the LEDs change status and the unit should reboot. After it has finished rebooting, iKConnect should be reset back to the state it was in when you first received it.

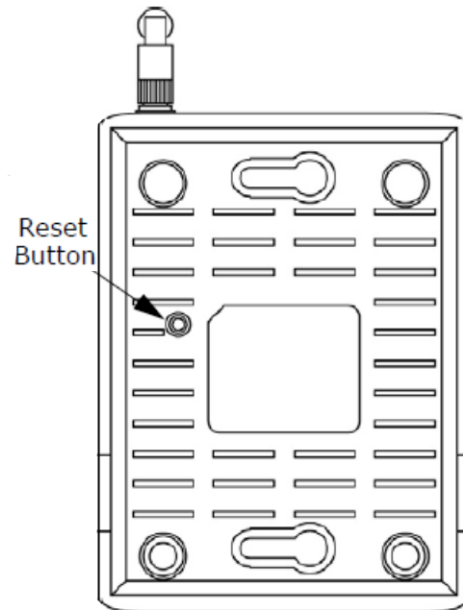

Figure 13